

Drying and heating chambers



Avantgarde.Line
ED | FD | FED series

Classic.Line
E | ED | FD | FED | FP | M series



Drying and heating chambers Avantgarde.Line

Series ED	Page 6
Series FD	Page 9
Series FED	Page 12
Options and Accessories	Page 15

BINDER drying chambers with natural convection or forced convection are renowned for their high quality and reliability. Thanks to their extensive redevelopment, these all-rounders are now even more firmly focused on addressing the requirements involved in drying or heating samples. What's more, in addition to the best energy efficiency on the market and convenient operation, the latest APT.line™ technology offers outstanding temperature accuracy to give this new generation of incubators real appeal.

PRODUCT SELECTION DRYING AND HEATING CHAMBERS AVANTGARDE.LINE

Features	ED › Page 6	FD › Page 9	FED › Page 12
Model			
Model 56	•	•	•
Model 115	•	•	•
Model 260	•	•	•
Model 720	•	•	•
General data			
Temperature range 5 °C above ambient temperature to [°C]	300	–	–
Temperature range 5-6 °C above ambient temperature to [°C]	300	–	–
Temperature range 10 °C above ambient temperature to [°C]	–	300	300
Temperature range 12 °C above ambient temperature to [°C]	–	300	300
Ethernet interface	–	–	•
USB interface	•	•	•
Natural convection	•	–	–
Forced convection	–	•	•
Controller and timer functions			
Controller display		LCD	
Ramp function	•	•	•
Time delayed OFF	•	•	•
Time delayed ON	–	–	•
Temperature dependent delayed OFF	–	–	•
Adjustable fan speed	–	–	•
Class 2 independent adjustable temperature safety device	•	•	•
Temperature alarm, visual	•	•	•

•Standard equipment

ADVANTAGES AT A GLANCE



EASY DATA LOGGING

Series ED, FD, FED

The USB connector, standard on the ED, FD and FED, provides easy data logging. Ethernet connectivity is standard on FED and an option for ED and FD.



BEST ENERGY EFFICIENCY ON THE MARKET AND LOW INSTALLATION REQUIREMENTS

Series ED, FD, FED

thanks to low heat dissipation and an optimized heating system.

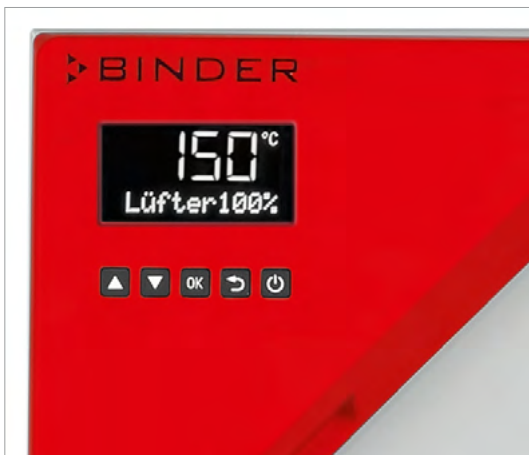

EASY, INTUITIVE HANDLING

Series ED, FD, FED

Our state-of-the-art controller with LCD display, excellent readability, alphanumeric display, and various functions provide a user friendly interface. Choice of languages as standard: English, German, and French.



COMPLETELY HOMOGENEOUS TEMPERATURE DISTRIBUTION

Series FD, FED

This feature provides excellent spatial and temporal temperature accuracy with the all-new generation of APT.line™ technology.

Series ED | with natural convection

The strengths of a BINDER ED series drying chamber include routine drying and sterilization tasks up to 300 °C. Thanks to the natural convection, all thermal processes which use this drying chamber are highly efficient. The ED series ensures fast, uniform drying.



ED 56 model

MAIN FEATURES

- Temperature range: ambient temperature plus 5 °C to 300 °C
- Up to 30% lower energy consumption compared to conventional units on the market
- High temperature accuracy thanks to APT.line™ technology
- Natural convection
- Controller with LCD display
- Electromechanical control of the exhaust air flap
- 2 chrome-plated racks
- Units up to 115 liters are stackable
- Class 2 integrated independent adjustable temperature safety device (DIN 12880) with visual alarm
- Ergonomic handle design

AVAILABLE SIZES

Model	Interior volume [L]	Online data sheets
ED 56	57	› go2binder.com/en-ED56
ED 115	114	› go2binder.com/en-ED115
ED 260	255	› go2binder.com/en-ED260
ED 720	743	› go2binder.com/en-ED720

› Other Classic.Line models › page 19



TIPS & TRICKS

Benefit from our many years of experience,

Tips & Tricks: › go2binder.com/en-tips-tricks

Case Studies: › go2binder.com/en-case-studies



Find all details online
go2binder.com/en-ED-a

TECHNICAL DATA

Description	ED 56	ED 115	ED 260	ED 720
Outer dimensions				
Width net [mm]	560	710	810	1165
Height net [mm]	625	735	965	1590
Depth net [mm]	565	605	760	870
Internal Dimensions				
Width [mm]	360	510	610	960
Height [mm]	420	530	760	1280
Depth [mm]	380	425	550	605
Measures				
Interior volume [L]	57	114	255	743
Net weight of the unit (empty) [kg]	39	54	85	169
permitted load [kg]	70	150	270	315
Load per rack [kg]	30	30	40	45
Performance Data Temperature				
Temperature range 5-6 °C above ambient temperature to [°C]	–	–	300	–
Temperature range 5 °C above ambient temperature to [°C]	300	300	–	300
Temperature variation at 150 °C [± K]	2.3	1.5	1.8	3.2
Temperature fluctuation at 150 °C [± K]	0.4	0.4	0.8	0.8
Heating-up time to 150 °C [min]	50	45	50	85
Recovery time after 30 seconds door open at 150 °C [min]	19	16	20	25
Electrical data				
Nominal power (version 120 V) [kW]	1.15	1.35	–	–
Nominal power (version 230 V) [kW]	1.05	1.25	2.25	–
Nominal power (version 240 V) [kW]	–	–	2.45	–
Nominal power (version 400 V) [kW]	–	–	–	4.1
Fixtures				
Number of shelves (std./max.)	2/4	2/5	2/8	2/16

ORDERING INFORMATION [Art. No.]

Further details: Go to www.binder-world.com > Search > Enter Article Number

Voltage	Option model	ED 56	ED 115	ED 260	ED 720
400 V 3 50/60 Hz	Standard	–	–	–	9010-0341
240 V 1 60 Hz	Standard	–	–	9010-0340	–
230 V 1 50/60 Hz	Standard	9010-0333	9010-0335	9010-0339	–
120 V 1 60 Hz	Standard	9010-0334	9010-0336	–	–

► You will find a selection of options, accessories and services suitable for each product on page 15

DIMENSIONS incl. fittings and connections [mm]

ED 56

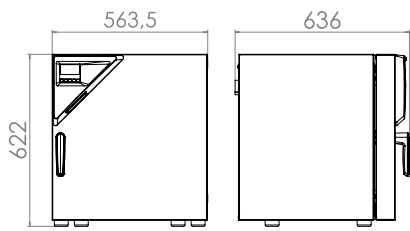

ED 115

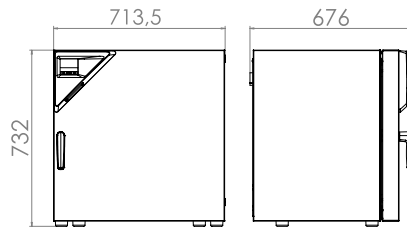

ED 260

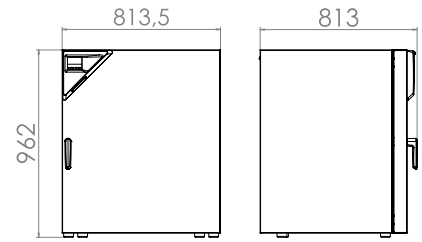

ED 720

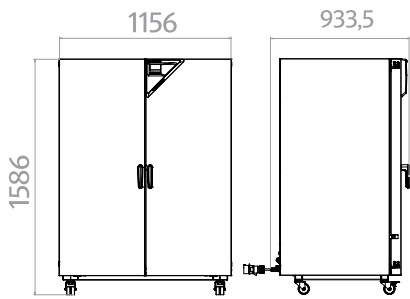

Series FD | with forced convection

A BINDER FD series Avantgarde.Line heating oven is always used when fast drying and sterilization is required. Thanks to its fully homogeneous temperature distribution, quick dynamics and powerful fan, this heating oven saves valuable time.



FD 56 model

MAIN FEATURES

- Temperature range: ambient temperature plus 10 °C to 300 °C
- High temperature accuracy thanks to APT.line™ technology
- Forced convection
- Controller with LCD display
- Electromechanical control of the exhaust air flap
- 2 chrome-plated racks
- Units up to 115 L are stackable
- Class 2 independent temperature safety device (DIN 12880) with visual temperature alarm
- Ergonomic handle design
- USB port for recording data

AVAILABLE SIZES

Model	Interior volume [L]	Online data sheets
FD 56	60	go2binder.com/en-FD56
FD 115	116	go2binder.com/en-FD115
FD 260	259	go2binder.com/en-FD260
FD 720	741	go2binder.com/en-FD720

► Other Classic.Line models ► page 19



TIPS & TRICKS

Benefit from our many years of experience,

Tips & Tricks: go2binder.com/en-tips-tricks

Case Studies: go2binder.com/en-case-studies



Find all details online
go2binder.com/en-FD-a

TECHNICAL DATA

Description	FD 56	FD 115	FD 260	FD 720
Outer dimensions				
Width net [mm]	560	710	810	1165
Height net [mm]	625	735	965	1590
Depth net [mm]	565	605	760	870
Internal Dimensions				
Width [mm]	400	550	650	1000
Height [mm]	440	550	780	1300
Depth [mm]	345	385	515	570
Measures				
Interior volume [L]	60	116	259	741
Net weight of the unit (empty) [kg]	39	54	85	162
permitted load [kg]	70	150	270	–
Load per rack [kg]	30	30	40	40
Performance Data Temperature				
Temperature range 10 °C above ambient temperature to [°C]	300	300	300	–
Temperature range 12 °C above ambient temperature to [°C]	–	–	–	300
Temperature variation at 150 °C [± K]	1.7	1.7	1.9	2.5
Temperature fluctuation at 150 °C [± K]	0.3	0.3	0.4	0.6
Heating-up time to 150 °C [min]	15	18	19	25
Recovery time after 30 seconds door open at 150 °C [min]	4	4	5	6
Electrical data				
Nominal power (version 120 V) [kW]	1.2	1.4	–	–
Nominal power (version 230 V) [kW]	1.1	1.3	2.3	–
Nominal power (version 240 V) [kW]	–	–	2.5	–
Nominal power (version 400 V) [kW]	–	–	–	4.5
Fixtures				
Number of shelves (std./max.)	2/4	2/5	2/8	2/16

ORDERING INFORMATION [Art. No.]

Further details: Go to www.binder-world.com > Search > Enter Article Number

Voltage	Option model	FD 56	FD 115	FD 260	FD 720
400 V 3 50/60 Hz	Standard	–	–	–	9010-0311
240 V 1 60 Hz	Standard	–	–	9010-0310	–
230 V 1 50/60 Hz	Standard	9010-0303	9010-0305	9010-0309	–
120 V 1 60 Hz	Standard	9010-0304	9010-0306	–	–

► You will find a selection of options, accessories and services suitable for each product on page 15

DIMENSIONS incl. fittings and connections [mm]

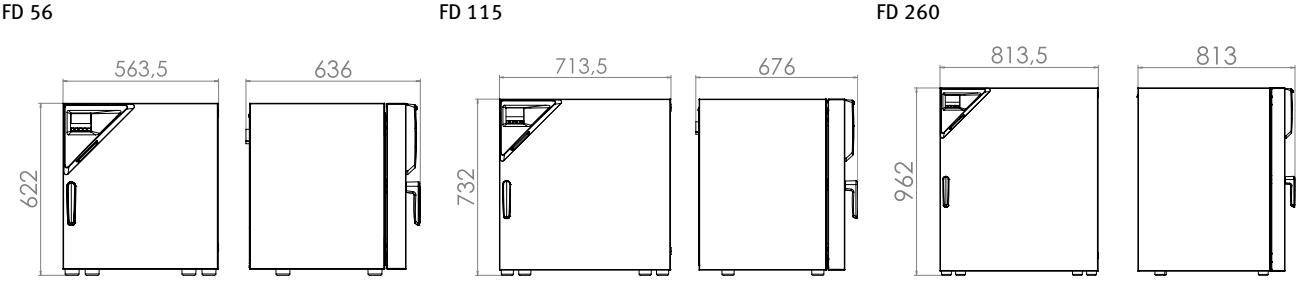

Series FED | with forced convection and enhanced timer functions

BINDER heating chambers of the FED Avantgarde.Line series provide almost unlimited capacity and are particularly adaptable. With advanced timing functions and a controllable fan, temperature and convection conditions are easily controlled.



FED 56 model

MAIN FEATURES

- Temperature range: ambient temperature plus 10 °C to 300 °C
- Up to 30% lower energy consumption compared to conventional units on the market
- High temperature accuracy thanks to APT.line™ technology
- Adjustable fan speed
- Controller with LCD display and enhanced time functions
- Electromechanical control of the exhaust air flap
- 2 chrome-plated racks
- Units up to 115 liters are stackable
- Class 2 integrated independent adjustable temperature safety device (DIN 12880) with visual alarm
- Ergonomic handle design

AVAILABLE SIZES

Model	Interior volume [L]	Online data sheets
FED 56	60	› go2binder.com/en-FED56
FED 115	116	› go2binder.com/en-FED115
FED 260	259	› go2binder.com/en-FED260
FED 720	741	› go2binder.com/en-FED720

› Other Classic.Line models › page 19

i **TIPS & TRICKS**

Benefit from our many years of experience,

Tips & Tricks: › go2binder.com/en-tips-tricks

Case Studies: › go2binder.com/en-case-studies

TECHNICAL DATA

Description	FED 56	FED 115	FED 260	FED 720
Outer dimensions				
Width net [mm]	560	710	810	1165
Height net [mm]	625	735	965	1590
Depth net [mm]	565	605	760	870
Internal Dimensions				
Width [mm]	400	550	650	1000
Height [mm]	440	550	780	1300
Depth [mm]	345	385	515	570
Measures				
Interior volume [L]	60	116	259	741
Net weight of the unit (empty) [kg]	39	54	85	162
permitted load [kg]	70	150	270	–
Load per rack [kg]	30	30	40	40
Performance Data Temperature				
Temperature range 10 °C above ambient temperature to [°C]	300	300	300	–
Temperature range 12 °C above ambient temperature to [°C]	–	–	–	300
Temperature variation at 150 °C [± K]	1.4	1.2	1.6	2
Temperature fluctuation at 150 °C [± K]	0.3	0.3	0.4	0.6
Heating-up time to 150 °C [min]	15	18	19	25
Recovery time after 30 seconds door open at 150 °C [min]	4	4	5	6
Electrical data				
Nominal power (version 120 V) [kW]	1.2	1.4	–	–
Nominal power (version 208 V) [kW]	–	–	–	4.5
Nominal power (version 230 V) [kW]	1.1	1.3	2.3	–
Nominal power (version 240 V) [kW]	–	–	2.5	–
Nominal power (version 400 V) [kW]	–	–	–	4.5
Fixtures				
Number of shelves (std./max.)	2/4	2/5	2/8	2/16

ORDERING INFORMATION [Art. No.]

Further details: Go to www.binder-world.com > Search > Enter Article Number

Voltage	Option model	FED 56	FED 115	FED 260	FED 720
400 V 3 50/60 Hz	Standard	–	–	–	9010-0301
240 V 1 60 Hz	Standard	–	–	9010-0300	–
230 V 1 50/60 Hz	Standard	9010-0295	9010-0293	9010-0299	–
208 V 3 60 Hz	Standard	–	–	–	9010-0302
120 V 1 60 Hz	Standard	9010-0296	9010-0294	–	–

► You will find a selection of options, accessories and services suitable for each product on page 15

DIMENSIONS incl. fittings and connections [mm]

FED 56

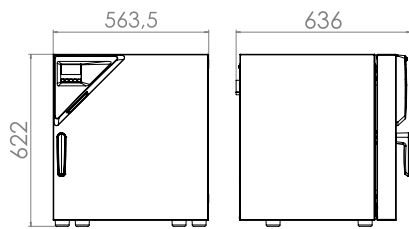

FED 115

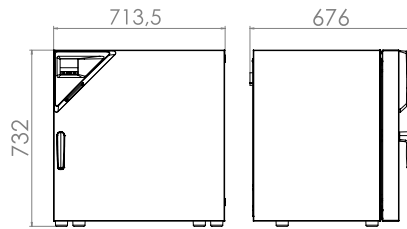

FED 260

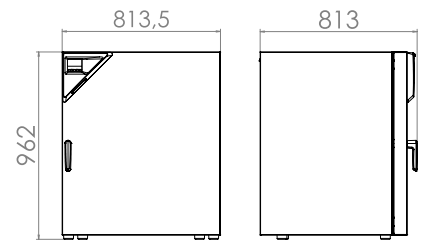

FED 720

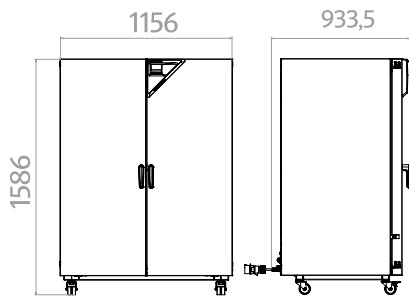

EXCERPT FROM OPTIONS AND ACCESSORIES

Access port with silicone plug	For introducing external measuring instruments. Large selection of different diameters and positions (left, right, or top) Series ED, FD, FED
Data Logger Kit T	Independent temperature data logging. The tailored product solution contains helpful accessories: From the magnetic mounting of the data logger to the BINDER unit and securing sensor cable for accurate readings. Series ED, FD, FED
Viewing window and interior lighting	Viewing window in the door with a triple-glazed insulating glass and interior lighting for easy visibility of the samples. Series ED, FD, FED
Shelf racks	Perforated shelves or shelf racks, chrome-plated or made from stainless steel. Series ED, FD, FED
HEPA air filter	Particle filter on fresh air supply for unit; filter classification H14 (acc. to. EN 1822-1:2009, > 99.995% at 0.3 µm). Series ED, FD, FED
Services	You can access our installation, maintenance, calibration, validation, or warranty services by taking out a Maintenance Service Agreement or by simply getting in touch when you need us. More information is available in the accessories and services chapter. Series ED, FD, FED
BINDER INDIVIDUAL	Using a BINDER series production product as a basis, we develop individual solutions as a single unit or in small batches. All products are tested, certified, and supplied with a full functional guarantee and warranty. More information is available in the accessories and services chapter. Series ED, FD, FED

► All extras online go2binder.com/en-options



Access port with silicone plug



Data Logger for temperature



Viewing window in the door



Shelf

Drying and heating chambers Classic.Line

Series E	Page 23
Series ED	Page 25
Series FD	Page 28
Series FED	Page 30
Series FP	Page 32
Series M	Page 35
Options and Accessories	Page 38

With natural or forced convection, all BINDER drying and heating chambers offer first-rate quality and process reliability. With its wide temperature range from 5 °C above ambient temperature to 300 °C, the heating chamber can be used in all applications. Short heating-up times and large power reserves are ideal for applications in science, research, and industry. The excellent thermal insulation also reduces operating costs. In its FP and M series, BINDER offers material test chambers with forced convection and customized programming.

PRODUCT SELECTION DRYING AND HEATING CHAMBERS CLASSIC.LINE

Features	E › Page 23	ED › Page 25	FD › Page 28	FED › Page 30	FP › Page 32	M › Page 35
Model						
Model 23	–	•	•	–	–	–
Model 28	•	–	–	–	–	–
Model 53	–	–	–	–	•	•
Model 115	–	–	–	–	•	•
Model 240	–	–	–	–	•	•
Model 400	–	•	–	•	•	•
Model 720	–	–	–	–	•	•
General data						
Temperature range [°C]	60...230	–	–	–	–	–
Temperature range 5 °C above ambient temperature to [°C]	–	300	300	300	300	300
RS 422 interface	–	–	•	•	•	•
Natural convection	•	•	–	–	–	–
Forced convection	–	–	•	•	•	•
Controller and timer functions						
Controller display	Analog	LED	LED	LED	LED	LCD color display
Ramp function	–	•	•	•	•	•
Time delayed OFF	–	•	•	•	•	–
Time delayed ON	–	–	–	•	•	•
Temperature dependent delayed OFF	–	–	–	•	•	–
Programming option	–	–	–	–	•	•
Weekly program function	–	–	–	–	•	•
Adjustable fan speed	–	–	–	•	•	•
Real-time clock	–	–	–	–	•	•
Class 2 independent adjustable temperature safety device	–	•	•	•	•	•
Temperature alarm, acoustic	–	–	–	–	–	•
Temperature alarm, visual	–	•	•	•	•	•

•Standard equipment

ADVANTAGES AT A GLANCE

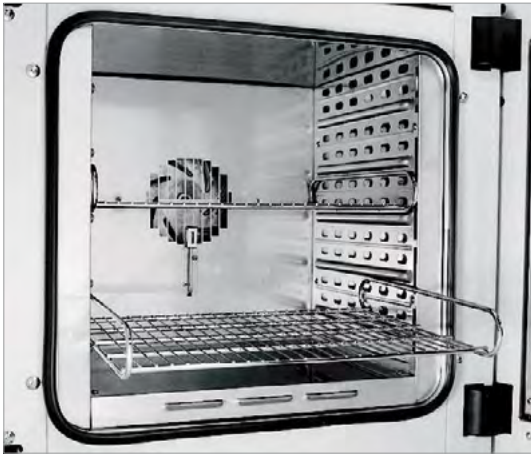

CONVENIENT WORK ENVIRONMENT

Series E, FD, FED, FP, M

BINDER interior concept: highlights rack with tilt protection, no permanent fixtures and stainless-steel inner chamber.

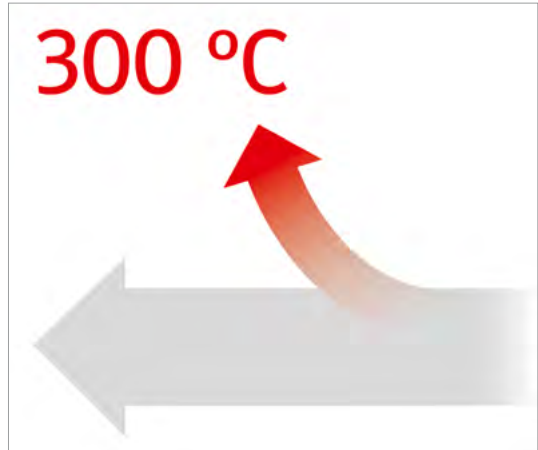

BROAD RANGE OF APPLICATIONS

Series ED, FD, FED, FP, M

Many different applications can take advantage of the wide temperature range from 5 °C above ambient temperature to 300 °C. The FP and M series also impress with their adjustable air change rates and large power reserves. Many different applications can take advantage of the wide temperature range from 5 °C above ambient temperature to 300 °C. The FP and M series also impress with their adjustable air change rates and large power reserves.

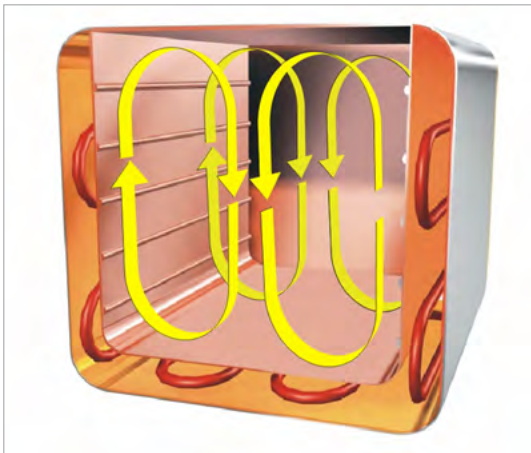

HOMOGENEOUS TEMPERATURE CONDITIONS WITH NATURAL CONVECTION

Series ED

Gentle temperature distribution provided by the APT.line™ preheating chamber technology.

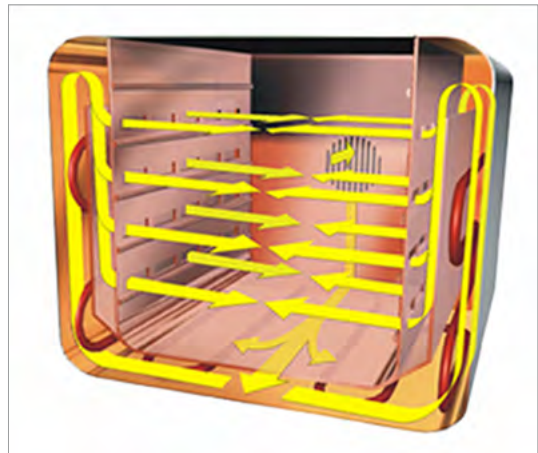

HOMOGENEOUS TEMPERATURE CONDITIONS WITH FORCED CONVECTION

Series FD, FED, FP, M

Long-term operational stability even under full load from the APT.line™ preheating chamber technology.

Series E | with mechanical adjustment

With a BINDER E series heating oven, you obtain a reliable and powerful unit in a solid configuration at a very attractive price. This heating oven is preferred for tasks in basic research, as well as in human and veterinary medicine.



E 28 model

MAIN FEATURES

- Temperature range: 60 °C to 230 °C
- Adjustable exhaust air flap
- Hydro-mechanical thermostat
- Class 1 temperature limitation device (Model E028-230V-T)
- Timer 0 – 120 min
- 2 chrome-plated racks

AVAILABLE SIZES

Model	Interior volume [L]	Online data sheets
E 28	28	› go2binder.com/en-E28

TECHNICAL DATA

Description	E 28
Outer dimensions	
Width net [mm]	580
Height net [mm]	405
Depth net [mm]	425
Internal Dimensions	
Width [mm]	400
Height [mm]	280
Depth [mm]	250
Measures	
Interior volume [L]	28
Net weight of the unit (empty) [kg]	22
permitted load [kg]	25
Load per rack [kg]	10
Performance Data Temperature	
Temperature range [°C]	60...230
Heating-up time to 150 °C [min]	36
Recovery time after 30 seconds door open at 150 °C [min]	19
Electrical data	
Nominal power (version 120 V) [kW]	0.8
Nominal power (version 230 V) [kW]	0.8
Fixtures	
Number of shelves (std./max.)	2/4

ORDERING INFORMATION [Art. No.]

Further details: Go to www.binder-world.com > Search > Enter Article Number

Voltage	Option model	E 28
230 V 1 50/60 Hz	Standard	9010-0001
	with TB class 1	9010-0003
120 V 1 60 Hz	Standard	9010-0106

► You will find a selection of options, accessories and services suitable for each product on page 38

DIMENSIONS incl. fittings and connections [mm]

E 28

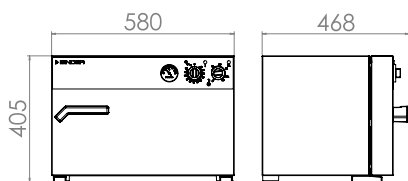

Series ED | with natural convection

The strengths of a BINDER ED series drying chamber include routine drying and sterilization tasks up to 300 °C. Thanks to the natural convection, all thermal processes which use this drying chamber are highly efficient. The ED series ensures fast, uniform drying.

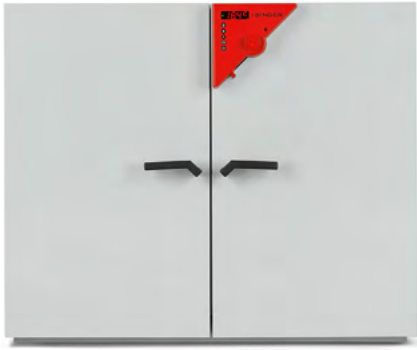

ED 400 model

MAIN FEATURES

- Temperature range: room temperature plus 5 °C to 300 °C
- APT.line™ preheating chamber technology
- Natural convection
- Adjustable exhaust air flap
- Controller with timer functions
- 2 chrome-plated racks
- Class 2 independent adjustable temperature safety device (DIN 12880) with visual alarm

AVAILABLE SIZES

Model	Interior volume [L]	Online data sheets
ED 23	20	› go2binder.com/en-ED23
ED 400	400	› go2binder.com/en-ED400

› Other Avantgarde.Line models › page 3

 Find all details online
go2binder.com/en-ED-c

TECHNICAL DATA

Description	ED 23	ED 400
Outer dimensions		
Width net [mm]	435	1235
Height net [mm]	495	1025
Depth net [mm]	520	765
Internal Dimensions		
Width [mm]	222	1000
Height [mm]	330	800
Depth [mm]	300	520
Measures		
Interior volume [L]	20	400
Net weight of the unit (empty) [kg]	27	125
permitted load [kg]	25	90
Load per rack [kg]	12	35
Performance Data Temperature		
Temperature range 5 °C above ambient temperature to [°C]	300	300
Temperature variation at 150 °C [± K]	2.8	3
Temperature fluctuation at 150 °C [± K]	0.5	0.5
Heating-up time to 150 °C [min]	28	71
Recovery time after 30 seconds door open at 150 °C [min]	28	31
Electrical data		
Nominal power (version 120 V) [kW]	0.8	–
Nominal power (version 208 V) [kW]	–	3.4
Nominal power (version 230 V) [kW]	0.8	–
Nominal power (version 400 V) [kW]	–	3.4
Fixtures		
Number of shelves (std./max.)	2/4	2/10

ORDERING INFORMATION [Art. No.]

Further details: Go to www.binder-world.com > Search > Enter Article Number

Voltage	Option model	ED 23	ED 400
400 V 3 50/60 Hz	with RS 422	–	9010-0075
	Standard	9010-0190	–
230 V 1 50/60 Hz	with RS 422	9010-0191	–
	Standard	9010-0192	–
208 V 3 60 Hz	with RS 422	–	9010-0168
	Standard	9010-0192	–
120 V 1 60 Hz	with RS 422	9010-0193	–
	Standard	9010-0192	–

► You will find a selection of options, accessories and services suitable for each product on page 38

DIMENSIONS incl. fittings and connections [mm]

ED 23

ED 400

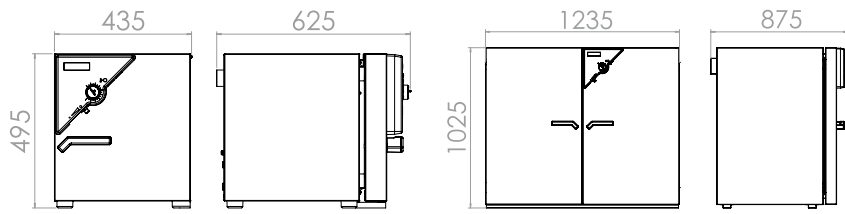

Series FD | with forced convection

A BINDER FD series heating oven is always used when fast drying and sterilization is required. Thanks to its fully homogeneous temperature distribution, quick dynamics and powerful fan, this heating oven saves valuable time.



FD 23 model

MAIN FEATURES

- Temperature range: room temperature plus 5 °C to 300 °C
- APT.line™ preheating chamber technology
- Forced convection
- Adjustable exhaust air flap
- Controller with timer functions
- 2 chrome-plated racks
- Class 2 independent adjustable temperature safety device (DIN 12880) with visual alarm

AVAILABLE SIZES

Model	Interior volume [L]	Online data sheets
FD 23	20	› go2binder.com/en-FD23

› Other Avantgarde.Line models › page 3



Find all details online
go2binder.com/en-FD-c

TECHNICAL DATA

Description	FD 23
Outer dimensions	
Width net [mm]	435
Height net [mm]	495
Depth net [mm]	520
Internal Dimensions	
Width [mm]	222
Height [mm]	330
Depth [mm]	300
Measures	
Interior volume [L]	20
Net weight of the unit (empty) [kg]	27
permitted load [kg]	25
Load per rack [kg]	12
Performance Data Temperature	
Temperature range 5 °C above ambient temperature to [°C]	300
Temperature variation at 150 °C [± K]	2.5
Temperature fluctuation at 150 °C [± K]	0.3
Heating-up time to 150 °C [min]	25
Recovery time after 30 seconds door open at 150 °C [min]	6
Electrical data	
Nominal power (version 120 V) [kW]	0.8
Nominal power (version 230 V) [kW]	0.8
Fixtures	
Number of shelves (std./max.)	2/4

ORDERING INFORMATION [Art. No.]

Further details: Go to www.binder-world.com > Search > Enter Article Number

Voltage	Option model	FD 23
230 V 1 50/60 Hz	Standard	9010-0194
120 V 1 60 Hz	Standard	9010-0196

► You will find a selection of options, accessories and services suitable for each product on page 38

DIMENSIONS incl. fittings and connections [mm]

FD 23

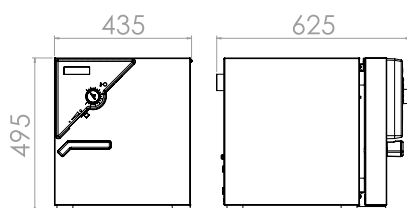

Series FED | with forced convection and enhanced timer functions

BINDER heating chambers of the FED series provide almost unlimited capacity and are particularly adaptable. With advanced timing functions and an adjustable fan, temperature and convection conditions are easily controlled.

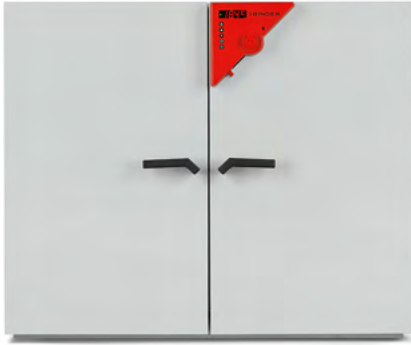

FED 400 model

MAIN FEATURES

- Temperature range: room temperature plus 5 °C to 300 °C
- APT.line™ preheating chamber technology
- Adjustable fan speed
- Adjustable exhaust air flap
- Controller with expanded timer functions
- 2 chrome-plated racks
- Class 2 independent adjustable temperature safety device (DIN 12880) with visual alarm
- Computer interface: RS 422

AVAILABLE SIZES

Model	Interior volume [L]	Online data sheets
FED 400	400	› go2binder.com/en-FED400

› Other Avantgarde.Line models › page 3



Find all details online
go2binder.com/en-FED-c

TECHNICAL DATA

Description	FED 400
Outer dimensions	
Width net [mm]	1235
Height net [mm]	1025
Depth net [mm]	765
Internal Dimensions	
Width [mm]	1000
Height [mm]	800
Depth [mm]	510
Measures	
Interior volume [L]	400
Net weight of the unit (empty) [kg]	145
permitted load [kg]	90
Load per rack [kg]	35
Performance Data Temperature	
Temperature range 5 °C above ambient temperature to [°C]	300
Temperature variation at 150 °C [± K]	3.8
Temperature fluctuation at 150 °C [± K]	0.7
Heating-up time to 150 °C [min]	29
Recovery time after 30 seconds door open at 150 °C [min]	6
Electrical data	
Nominal power (version 208 V) [kW]	3.4
Nominal power (version 400 V) [kW]	3.4
Fixtures	
Number of shelves (std./max.)	2/10

ORDERING INFORMATION [Art. No.]

Further details: Go to www.binder-world.com > Search > Enter Article Number

Voltage	Option model	FED 400
400 V 3 50/60 Hz	Standard	9010-0216
208 V 3 60 Hz	Standard	9010-0217

► You will find a selection of options, accessories and services suitable for each product on page 38

DIMENSIONS incl. fittings and connections [mm]

FED 400

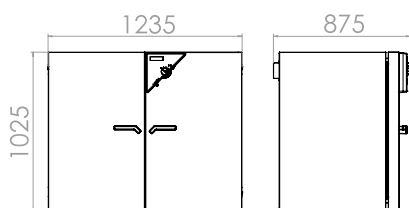

Series FP | with forced convection and program functions

A BINDER material test chamber with mechanical convection of the FP series provides reliably short drying times and particularly fast heating – even for chambers under full loads.



FP 115 model

MAIN FEATURES

- Temperature range: room temperature plus 5 °C to 300 °C
- APT.line™ preheating chamber technology
- Adjustable fan speed
- Adjustable exhaust air flap
- Controller with time-segment and real-time programming
- 2 chrome-plated racks
- Class 2 independent adjustable temperature safety device (DIN 12880) with visual alarm
- Computer interface: RS 422

AVAILABLE SIZES

Model	Interior volume [L]	Online data sheets
FP 53	53	› go2binder.com/en-FP53
FP 115	115	› go2binder.com/en-FP115
FP 240	240	› go2binder.com/en-FP240
FP 400	400	› go2binder.com/en-FP400
FP 720	720	› go2binder.com/en-FP720



TIPS & TRICKS

Benefit from our many years of experience,

Tips & Tricks: › go2binder.com/en-tips-tricks

Case Studies: › go2binder.com/en-case-studies



Find all details online
go2binder.com/en-FP-c

TECHNICAL DATA

Description	FP 53	FP 115	FP 240	FP 400	FP 720
Outer dimensions					
Width net [mm]	635	835	1035	1235	1235
Height net [mm]	620	705	825	1025	1530
Depth net [mm]	575	645	745	765	865
Internal Dimensions					
Width [mm]	400	600	800	1000	1000
Height [mm]	400	480	600	800	1200
Depth [mm]	340	410	510	510	610
Measures					
Interior volume [L]	53	115	240	400	720
Net weight of the unit (empty) [kg]	44	62	96	145	194
permitted load [kg]	40	50	70	90	120
Load per rack [kg]	15	20	30	35	45
Performance Data Temperature					
Temperature range 5 °C above ambient temperature to [°C]	300	300	300	300	300
Temperature variation at 150 °C [± K]	2	1.8	2	2.5	2
Temperature fluctuation at 150 °C [± K]	0.3	0.3	0.3	0.3	0.3
Heating-up time to 150 °C [min]	24	30	27	35	39
Recovery time after 30 seconds door open at 150 °C [min]	5	8	10	17	20
Electrical data					
Nominal power (version 120 V) [kW]	1.2	1.6	–	–	–
Nominal power (version 208 V) [kW]	–	–	2.7	3.4	5
Nominal power (version 230 V) [kW]	1.2	1.6	2.7	–	–
Nominal power (version 400 V) [kW]	–	–	–	3.4	5
Fixtures					
Number of shelves (std./max.)	2/5	2/6	2/7	2/10	2/16

ORDERING INFORMATION [Art. No.]

Further details: Go to www.binder-world.com > Search > Enter Article Number

Voltage	Option model	FP 53	FP 115	FP 240	FP 400	FP 720
400 V 3 50/60 Hz	Standard	–	–	–	9010-0265	9010-0267
230 V 1 50/60 Hz	Standard	9010-0153	9010-0255	9010-0263	–	–
208 V 1 60 Hz	Standard	–	–	9010-0264	9010-0266	9010-0268
120 V 1 60 Hz	Standard	9010-0175	9010-0262	–	–	–

► You will find a selection of options, accessories and services suitable for each product on page 38

DIMENSIONS incl. fittings and connections [mm]

FP 53

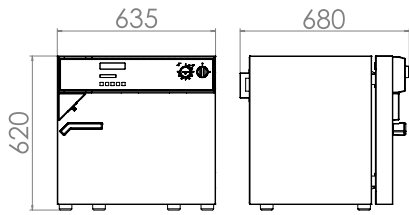

FP 115

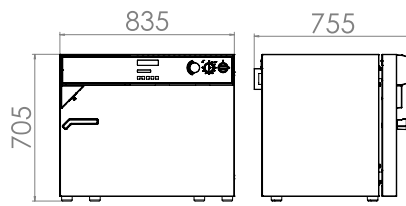

FP 240

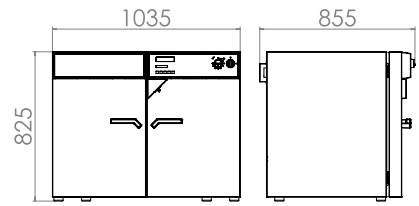

FP 400

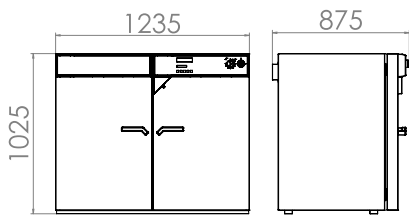

FP 720

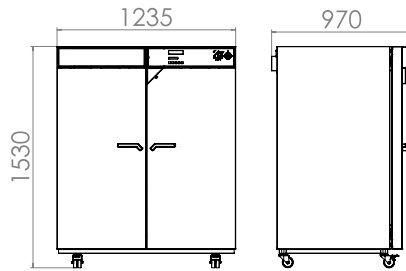

Series M | with forced convection and advanced program functions

With a maximum of 300 °C and various programming options the M series material test chambers are ideal for material and aging tests. With a high air flow, the powerful fans ensure rapid heating.



M 53 model

MAIN FEATURES

- Temperature range: room temperature plus 5 °C to 300 °C
- APT.line™ preheating chamber technology
- Adjustable fan speed
- Program-controlled ventilation flap
- Color LCD controller with time-segment programming
- 2 chrome-plated racks
- Class 2 independent adjustable temperature safety device (DIN 12880) with visual alarm
- Computer interface: RS 422

AVAILABLE SIZES

Model	Interior volume [L]	Online data sheets
M 53	53	› go2binder.com/en-M53
M 115	115	› go2binder.com/en-M115
M 240	240	› go2binder.com/en-M240
M 400	400	› go2binder.com/en-M400
M 720	720	› go2binder.com/en-M720



TIPS & TRICKS

Benefit from our many years of experience,

Tips & Tricks: › go2binder.com/en-tips-tricks

Case Studies: › go2binder.com/en-case-studies



Find all details online
go2binder.com/en-M-c

TECHNICAL DATA

Description	M 53	M 115	M 240	M 400	M 720
Outer dimensions					
Width net [mm]	635	835	1035	1235	1235
Height net [mm]	780	865	985	1190	1690
Depth net [mm]	575	645	745	795	865
Internal Dimensions					
Width [mm]	400	600	800	1000	1000
Height [mm]	400	480	600	800	1200
Depth [mm]	340	410	510	510	610
Measures					
Interior volume [L]	53	115	240	400	720
Net weight of the unit (empty) [kg]	61	89	131	173	203
permitted load [kg]	40	50	70	90	120
Load per rack [kg]	15	20	30	35	45
Performance Data Temperature					
Temperature range 5 °C above ambient temperature to [°C]	300	300	300	300	300
Temperature variation at 150 °C [± K]	1.3	1.5	1.5	1.5	1.9
Temperature fluctuation at 150 °C [± K]	0.3	0.3	0.3	0.3	0.3
Heating-up time to 150 °C [min]	15	16	19	18	21
Recovery time after 30 seconds door open at 150 °C [min]	3	3	3	3	3
Electrical data					
Nominal power (version 230 V) [kW]	1.2	1.6	2.7	–	–
Nominal power (version 400 V) [kW]	–	–	–	3.4	5
Fixtures					
Number of shelves (std./max.)	2/5	2/6	2/7	2/10	2/16

ORDERING INFORMATION [Art. No.]

Further details: Go to www.binder-world.com > Search > Enter Article Number

Voltage	Option model	M 53	M 115	M 240	M 400	M 720
400 V 3 50/60 Hz	Standard	–	–	–	9010-0204	9010-0205
230 V 1 50/60 Hz	Standard	9010-0201	9010-0202	9010-0203	–	–

► You will find a selection of options, accessories and services suitable for each product on page 38

DIMENSIONS incl. fittings and connections [mm]

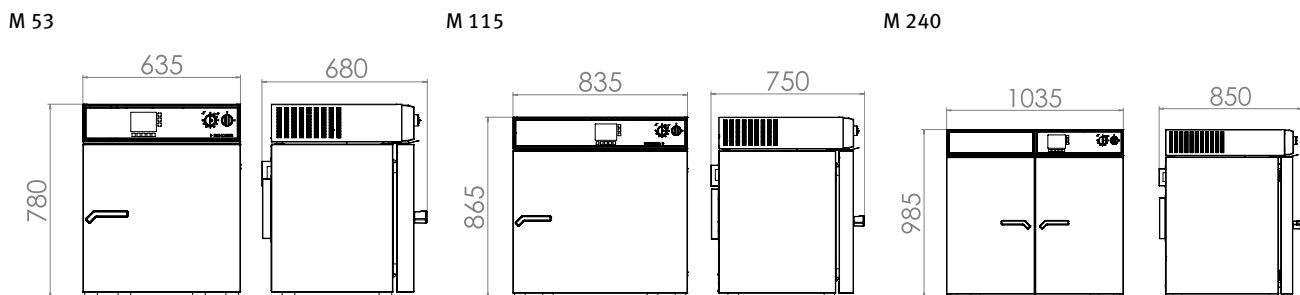

M 400

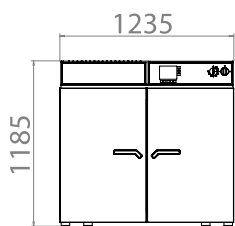

M 720

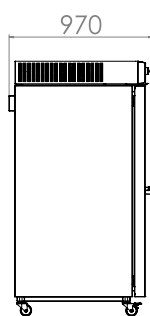
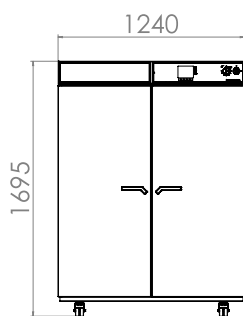
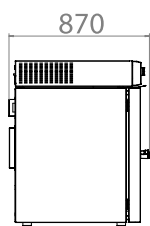

EXCERPT FROM OPTIONS AND ACCESSORIES

Access port with silicone plug For introducing external measuring instruments. Large selection of different diameters and positions (left, right, or top)
Series ED, FD, FED, FP, M

Viewing window and interior lighting Viewing window in the door with interior lighting for easy samples viewing.
Series ED, FD, FED, FP, M

Shelf racks Perforated shelves or shelf racks, chrome-plated or made from stainless steel.
Series E, ED, FD, FED, FP, M

Services You can access our installation, maintenance, calibration, validation, or warranty services by taking out a Maintenance Service Agreement or by simply getting in touch when you need us. More information is available in the accessories and services chapter.
Series E, ED, FD, FED, FP, M

BINDER INDIVIDUAL Using a BINDER series production product as a basis, we develop individual solutions as a single unit or in small batches. All products are tested, certified, and supplied with a full functional guarantee and warranty. More information is available in the accessories and services chapter.
Series E, ED, FD, FED, FP, M

► All extras online go2binder.com/en-options



Access port with silicone plug



Viewing window in the door



Shelf

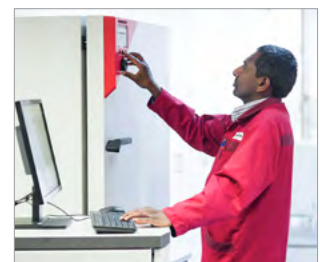

Services

BINDER products

CO₂ incubators

Incubators

Cooling incubators

Growth chambers

Ultralow temperature freezers

Drying and heating chambers

Safety drying chambers

Vacuum drying chambers

Constant climate chambers

Dynamic climate chambers



Never miss a product novelty -
Subscribe and keep up to speed with
the BINDER monthly newsletter.

Subscription

go2binder.com/en-newsletter-subscription



Best conditions for your success

BINDER GmbH

Tuttlingen, Germany

Tel +49 7462 2005 0
Fax +49 7462 2005 100
info@binder-world.com
www.binder-world.com

BINDER Asia Pacific (Hong Kong) Ltd.

Kowloon, Hong Kong, P.R. China

Tel +852 39070500
Fax +852 39070507
asia@binder-world.com
www.binder-world.com

BINDER Environmental Testing Equipment (Shanghai) Co., Ltd.

Shanghai, P.R.China

Tel +86 21 685 808 25
Fax +86 21 685 808 29
china@binder-world.com
www.binder-world.com

Representative Office for CIS

Moscow, Russia

Tel +7 495 988 15 16
Fax +7 495 988 15 17
russia@binder-world.com
www.binder-world.ru

BINDER Inc.

Bohemia, NY, USA

Tel +1 631 224 4340
Fax +1 631 224 4354
usa@binder-world.com
www.binder-world.us