

PC 3001 VARIO select

*vacuubrand*



# VARIO select

THE NEW CHEMISTRY VACUUM PUMPS

easy, efficient and extremely durable



Technology for Vacuum Systems

## **VARIO select chemistry vacuum pumps** **easy, efficient and extremely durable**

The combination of speed controlled VARIO chemistry diaphragm pumps and the new VACUU-SELECT vacuum controller makes the VARIO select chemistry pumps the ideal solution for chemical processes that require precise vacuum, such as rotary evaporation, vacuum drying or vacuum concentration.

Thanks to their uncompromising chemical resistance, VACUUBRAND chemistry diaphragm pumps are ideally suited for pumping aggressive gases and vapours. With the VACUU-SELECT controller setting the optimum process pressure becomes a simple task. The intuitive control and broad range of useful functions ensure that your process runs smoothly and in the shortest possible time.

VARIO technology controls the vacuum precisely and efficiently via motor speed. Power consumption, maintenance and noise are exceptionally low. The outlet catchpot and solvent condenser combine to prevent solvent vapor emissions into the lab, allowing for nearly full recovery of solvents.





## VACUUBRAND® Quality

### Unsurpassed long-term performance

VACUUBRAND chemistry diaphragm pumps offer unsurpassed long-term performance – even in demanding conditions. Thanks to high-quality fluoropolymers, precise manufacturing processes, and 100 % quality control, VACUUBRAND chemistry diaphragm pumps guarantee uncompromising chemical resistance, long service intervals, and longstanding reliability.

## VARIO® Control

### Efficient and whisper quiet

VARIO-pumps provide pinpoint vacuum control by adjusting the motor speed. This guarantees optimal process times and reproducible results. VARIO-pumps run on demand for maximum energy efficiency, increased service intervals, and whisper quiet operation.

## VACUU-SELECT® Controller

### Keep it simple

The new VACUU-SELECT vacuum controller makes your tasks simple, easy, and efficient. Choose your application from a set of predefined applications or create your own routine in next to no time. Everything is right at your fingertips with the intuitive VACUU-SELECT user interface.

No more “babysitting” – with automatic evaporation, boiling points are detected at the touch of a button and the pressure is continuously adapted throughout the evaporation. Even critical solvent mixtures are quickly and safely evaporated without bumping or foaming.

Uncompromising chemical resistance

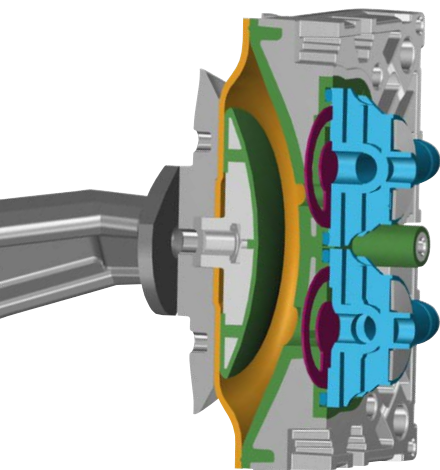

Pump chamber of a chemistry diaphragm pump

Proven chemical resistant materials

- glass touch panel display
- ceramic vacuum sensor
- chemical resistant wetted materials:

ETFE

Head cover and clamping disc are made of thick walled molded ETFE with metal core for unsurpassed long-term performance.

ECTFE

Valve connectors are made of ECTFE for an optimum of thermal, mechanical and chemical resistance.

PTFE

Well-proven PTFE sandwich diaphragms for increased reliability and extended service life.

FFKM

Inlet and outlet flapper valves are made of FFKM or PTFE for both highest leakage tightness and best chemical resistance.

Chemistry compatibility of VACUUBRAND chemistry diaphragm pumps

- PTFE:** Polytetrafluoroethylene
- ETFE:** Ethylene tetrafluoroethylene
- ECTFE:** Ethylene chlorotrifluoroethylene
- FFKM:** Perfluoro elastomer

- ++ excellent chemical resistance
- + good to limited chemical resistance
- poor chemical resistance
- \* for some solvents '+'

	PTFE	ETFE/ECTFE	FFKM
<b>Acid amides</b> Dimethylformamide (DMF), Acetamide, Formamide	++	++	++
<b>Acids, dilute or weak</b> Acetic acid, Carbonic acid, Butyric acid	++	++	++
<b>Acids, strong or concentrated</b> Hydrochloric acid, Sulfuric acid, Nitric acid, Trifluoroacetic acid (TFA)	++	++	++
<b>Alcohols, aliphatic</b> Methanol, Ethanol, Butanol	++	++	++
<b>Aldehydes</b> Formaldehyde, Ethanal, Hexanal	++	++	++
<b>Amines</b> N-Methyl-2-pyrrolidone (NMP), Triethylamine	++	++	+
<b>Bases</b> Sodium hydroxide, Potassium hydroxide, Ammonia	++	++	++
<b>Esters</b> Ethyl acetate, Butyl formate, Amyl butyrate	++	++	++
<b>Ethers</b> Diethyl ether, Tetrahydrofuran, Dioxane	++	++	++
<b>Hydrocarbons, aliphatic</b> Pentane, Hexane, Heptane	++	++	++
<b>Hydrocarbons, aromatic</b> Benzene, Toluene, Xylene	++	++	++
<b>Hydrocarbons, halogenated</b> Methyl chloride, Chloroform, Ethylene chloride	++	++	++
<b>Ketones</b> Acetone, Cyclohexanone	++	++*	++
<b>Oxidizing acids, oxidizing agents</b> Ozone, Hydrogen peroxide, Chlorine	++	+	++
<b>Sulfoxides</b> Dimethyl sulfoxide (DMSO)	++	++	++

The data are based on information from various literature. VACUUBRAND does not warrant the accuracy of these data. Due to the variety of possible influencing factors, they can serve only as a guide. No legal claims may be derived from user reliance on these data.

## The VACUUBRAND stability core principle

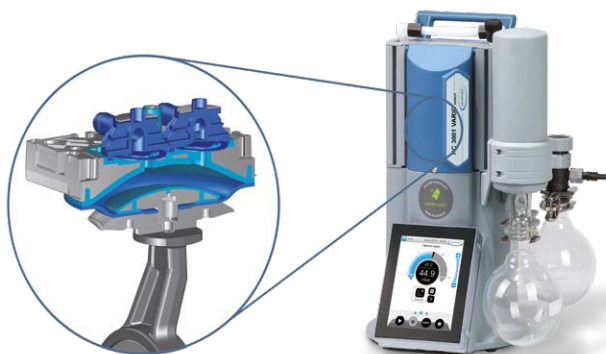

### Unsurpassed long-term performance

The unique stability core design of high-stress components - such as the head cover and diaphragm clamping disc - ensure reliable performance over the long term. The stability core is created through a multi-step manufacturing process which creates a thick layer of fluoropolymer wetted material. Together with the perfluoroelastomer valves and seals, these materials provide outstanding chemical resistance and minimal surface adherence. This prevents the degradation of the pump from chemical corrosion.

## Highest quality requirements



Bild: Dr. Schönheit + P. Consulting GmbH

### Made in Wertheim

We engineer and produce nearly all pump and controller components in our factory in Wertheim, Germany.

VACUUBRAND pumps were introduced to the market in 1961. From 1961 up to today, all of our products are produced at our factory in Wertheim, Baden-Württemberg, delivering on the high quality expectations of products bearing the "Made in Germany" label.



### 100 % quality control

Each vacuum pump goes through an extensive performance test at our facility, measuring specifications and equipment reliability with computer-controlled measuring and test machines and a fully automatic final test stand. That is how we guarantee that vacuum pumps from VACUUBRAND are not only designed to an exceptionally high-level engineering standard, but also offer extraordinary lifetime cost advantages because of their low service costs and above-average lifetimes.



## Precisely optimized vacuum

VARIO pumps combined with the VACUU-SELECT controller deliver unparalleled precision, free of hysteresis. Pumping speed automatically adjusts in real-time to optimize gas flow based on the rate of evaporation or gas load, and the system volume. VARIO control always seeks to optimize process conditions and minimize process time.

### Classic 2-point vacuum valve control

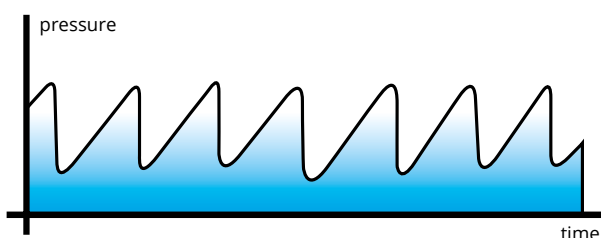

- control by opening and closing a vacuum valve
- pump always runs at full speed
- vacuum fluctuates between two tolerance values

### Pinpoint VARIO control via motor speed control



- control via motor speed of the pump
- pump speed adjusts in realtime
- pinpoint vacuum
- minimizes process times, saving as much as 30% compared to other control methods

## Automatic evaporation

In Automatic Evaporation mode, the new VACUU-SELECT controller automatically detects solvent vapor pressures. With continuous optimization of the vacuum level based on real-time process conditions, there is no need to actively monitor your process - no more babysitting is required. Just press start and walk away.

- reliably maintains control for you - no more babysitting
- makes manual adjustments and programming a thing of the past
- minimizes foaming and sample loss



## Whisper quiet operation



The patented new drive system of our chemistry diaphragm pumps guarantees extra quiet, ultra-low-vibration operation. Due to the VARIO control, the pump runs at a significantly reduced speed making the pump whisper quiet.

## Reduced power consumption and long service intervals



In comparison to vacuum pumps with constant motor speed, power consumption is reduced by up to 90 % during laboratory operation. The intelligent VARIO motor speed control minimizes wear on the pumps. The already long diaphragm life time of approximately 15.000 working hours is increased considerably further, resulting in exceptionally long service intervals.



### **This pump won't quit!**

Typical maintenance intervals for the PC 3001 VARIO select are 5 years or more.

# VACUU-SELECT® Controller

## Intuitive user interface

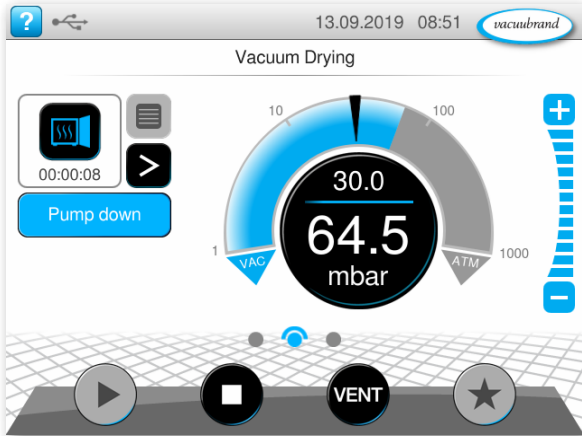

Using the VACUU-SELECT controller is just like using a smartphone. Interactive menus designed specifically for lab applications get you up and running in no time.

- application-based navigation
- integrated contextual help function with application-specific tips
- choose from 14 languages



## Ready to use vacuum procedures for all common applications



VACUU-SELECT includes predefined vacuum procedures for all common lab applications. The process steps and control parameters can easily be adjusted to suit any application.

It's as simple as

- pick your application
- use the predefined parameters or adjust as necessary
- press Start

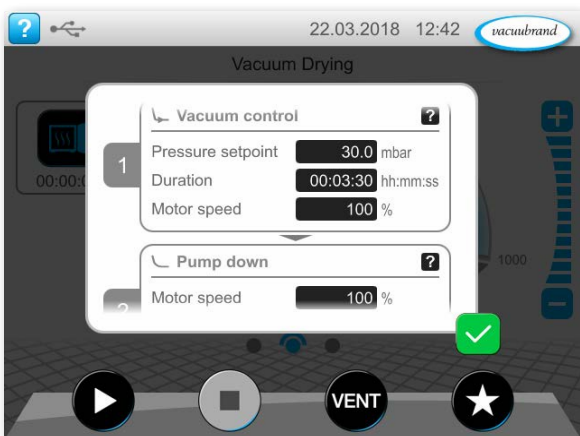





## Fully automatic evaporations at the touch of a button



Automatic evaporation mode is perfect for controlling applications like rotary evaporation or vacuum distillation. Simply press the start button and the boiling pressure will be detected automatically. As needed, adjustments are made automatically until the process is complete. This makes the process run quickly, and without foaming. There's no need for manual adjustments or constant babysitting.



## Easy customization through drag and drop editing

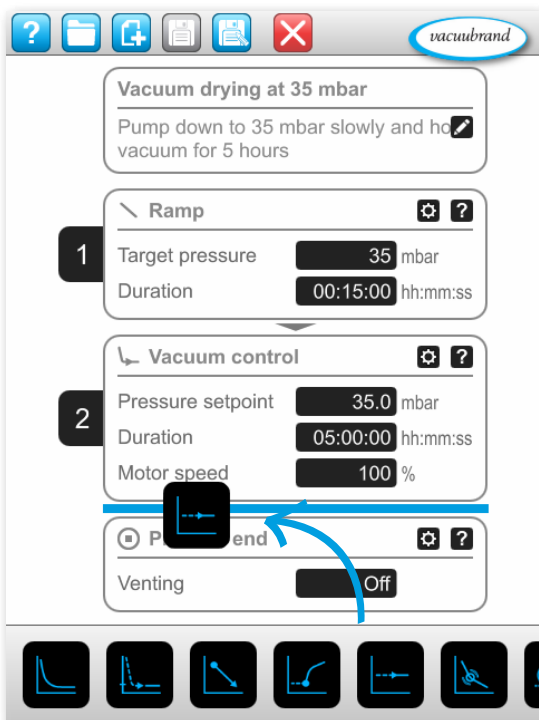

Use the new drag and drop editor to adapt the pre-defined processes for your work. Insert, delete, and modify process steps in an instant to create individualized vacuum processes. Once created, your process will run exactly the same way, time after time. This ensures reproducibility and frees up time for other tasks.

It's as simple as

- drag & drop the desired process steps into the right sequence
- adjust the parameters, like target pressure or duration
- save your customized application and make it a Favorite
- select it from the Favorites menu and hit Start

## Product range

### From laboratory to mini-plant

VACUUBRAND offers the VARIO chemistry diaphragm pump technology for a wide range of operations. Models with pumping speeds ranging from 2 m<sup>3</sup>/h to nearly 20 m<sup>3</sup>/h support applications ranging from individual laboratory applications such as rotary evaporators, to multi-user lab vacuum networks, to replacement of rotary vane pumps in kilo labs and pilot plants. Available pump models offer ultimate vacuum ratings between 70 mbar and even down to 0.6 mbar. Select the right pumping unit for evaporation of your low- or high-boiling-point solvents at low temperatures.



product	ultimate vacuum	max. flowrate	Ord. No.		
PC 3001 VARIO select	2 mbar	2 m <sup>3</sup> /h	CEE: 20700200	CH: 20700201	UK: 20700202
			US: 20700203	CN: 20700206	IN: 20700207



product	ultimate vacuum	max. flowrate	Ord. No.		
PC 3002 VARIO select	7 mbar	2.8 m <sup>3</sup> /h	CEE: 20733550	CH: 20733551	UK: 20733552
PC 3004 VARIO select	1.5 mbar	4.6 m <sup>3</sup> /h	US: 20733553	CN: 20733556	IN: 20733557
			CEE: 20737550	CH: 20737551	UK: 20737552
PC 3003 VARIO select	0.6 mbar	2.8 m <sup>3</sup> /h	US: 20737553	CN: 20737556	IN: 20737557
			CEE: 20738450	CH: 20738451	UK: 20738452
			US: 20738453	IN: 20738456	IN: 20738457



product	ultimate vacuum	max. flowrate	Ord. No.		
PC 3016 VARIO select	70 mbar	20 m <sup>3</sup> /h	CEE: 20741850	US: 20741853	
PC 3012 VARIO select	1.5 mbar	15 m <sup>3</sup> /h	CEE: 20743850	CH: 20743851	UK: 20743852
			US: 20743853	CN: 20743856	IN: 20743857
PC 3010 VARIO select	0.6 mbar	13 m <sup>3</sup> /h	CEE: 20744850	CH: 20744851	UK: 20744852
			US: 20744853	CN: 20744856	IN: 20744857

### The right VARIO®-Pump for your application



#### Rotary evaporators / reactors

The **PC 3001 VARIO select** is ideal for vacuum applications with high boiling solvents. The hysteresis-free vacuum control prevents superheating and foaming to protect valuable process samples. The controller enables automatic detection of vapor pressures and automatic adjustment of the vacuum level to the process requirements. For large evaporation flasks (> 5 l), the **PC 3004 VARIO select** with a max. flow rate of 4.6 m<sup>3</sup>/h is ideal for handling large quantities of vapor in a short time.



#### Vacuum drying chambers

Vacuum drying chambers are used for drying very sensitive substances and when it is necessary to guarantee excellent residual drying. They generally need a very good ultimate vacuum depending upon the degree of drying, maximum acceptable temperature and the solvents used. For small volumes (drying chamber < 30 l) the **PC 3001 VARIO select** meets these requirements. Large quantities of vapors can only be handled with pump systems with a sufficiently large volume flow rate. Our product recommendations:

**PC 3004 VARIO select** (drying chamber < 60 l) or **PC 3012 VARIO select** (drying chamber < 120 l).

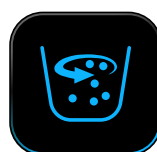

#### Vacuum concentrators

With **PC 3001 VARIO select** even high boiling solvents, or samples that are prone to bumping can be easily concentrated using automatic evaporation. Quick, easy, and without any user input. For solvents with extremely high boiling points of more than 150 °C we recommend the **PC 3003 VARIO select** with an ultimate vacuum of 0.6 mbar.



#### Oil-free vacuum for kilo labs

In kilo labs and pilot plants, materials are produced in quantities of a few hundred grams to several kilograms for pharmaceutical development, safety studies and early clinical trials for new drugs. Based on their powerful flow rates, our high performance chemistry pumping units **PC 3012 VARIO select** or **PC 3010 VARIO select** are perfectly suited for these applications.



#### Operation in a VACUU-LAN® local area network

VACUU-LAN vacuum networks make it possible to supply high performance vacuum to several different applications from one vacuum pump (e.g., **PC 3002 VARIO select**, **PC 3004 VARIO select**, **PC 3012 VARIO select** or **PC 3016 VARIO select**). This is a money- and space-saving solution when several users are working with vacuum in one laboratory and avoids the many drawbacks of a central ("house") vacuum supply.



#### Vacuum Pump Selection Guide - Find the right vacuum pump for your application

Use our online selection tool at [www.vacuubrand.com/vpsg](http://www.vacuubrand.com/vpsg) or contact us - we will be happy to assist you!

Headquarter in Germany  
VACUUBRAND GMBH + CO KG  
T +49 9342 808-5550  
[info@vacuubrand.com](mailto:info@vacuubrand.com)

North American subsidiary in Essex, CT:  
VACUUBRAND INC  
T +1 860 767 5341, toll free in USA: +1 888 882 6730  
[info@vacuubrand.net](mailto:info@vacuubrand.net)

Headquarter in Germany

VACUUBRAND GMBH + CO KG  
Alfred-Zippe-Straße 4  
97877 Wertheim, Germany

T +49 9342 808-5550  
F +49 9342 808-5555

[info@vacuubrand.com](mailto:info@vacuubrand.com)  
[www.vacuubrand.com](http://www.vacuubrand.com)

North American subsidiary

VACUUBRAND INC  
11 Bokum Road  
Essex, CT 06426-1506, United States of America

T +1 860 767 5341  
Toll Free in USA: +1 888 882 6730

[info@vacuubrand.net](mailto:info@vacuubrand.net)  
[www.vacuubrand.com/us](http://www.vacuubrand.com/us)

California Residents:  
For more information concerning  
California Proposition 65, please go to  
[www.vacuubrand.com/calprop65](http://www.vacuubrand.com/calprop65)